

Two-color Digital Display Pressure Sensor

AP-30 Series

Instruction Manual



PART NAMES AND FUNCTIONS

AUTO key

In auto-tuning mode, use this key to detect pressure. In measurement mode, press this key for 2 seconds or more to adjust the zero-point.

SET key

Use this key to display or change preset values.

Output indicator 2 (Green LED)

Display unit label

Output indicator 1 (Red LED)

UP/DOWN key

Use these keys to set output modes, or to change preset values or units.

Housing

Hexagonal socket bolt

Rear metal casing (Die-cast zinc)

Display unit label

The AP-30 series enables you to select the display units for pressure. Attach the included display unit label for the desired units at the position in the figure.

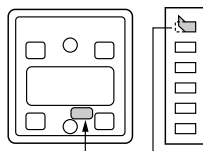

SPECIFICATIONS

Type	Negative pressure	Positive pressure		Compound pressure
Model ¹	AP-31(Z)	AP-32(Z)	AP-33(Z)	AP-34(Z)
Rated pressure	0 to -101.3 kPa (0 to -760 mmHg)	0 to 100.0 kPa (0 to 1 kgf/cm ²)	0 to 1.000 MPa (0 to 10 kgf/cm ²)	+101.3 to -101.3 kPa (+760 mmHg to -760 mmHg)
Proof pressure	490 kPa (5 kgf/cm ²)	490 kPa (5 kgf/cm ²)	1.47 MPa (15 kgf/cm ²)	490 kPa (5 kgf/cm ²)
Pressure type	Gauge pressure			
Fluid types	Air or noncorrosive gases			
Display	3 1/2-digit, 2-color, 7-segment LED (Character height: 11 mm)			
Display resolution	0.1 kPa, 1 mmHg, 0.02 Psi	0.1 kPa, 0.001kgf/cm ² , 0.02 Psi	0.001 Mpa, 0.01kgf/cm ² , 0.2 Psi	0.2 kPa, 2 mmHg, 0.04 Psi
Detectable pressure range	-15% to +110% of F.S.			
Repeatability	±0.2% of F.S. (5 ms or more)			
Response time (chattering prevention function)	2.5/5/100/500 ms (selectable)			
Zero-shift input ²	Non-voltage input (contact, solid-state), Input time: 20 ms or more			
Control output	NPN open-collector: 100 mA max. (40 V max.), Residual voltage: 1 V max. 2-output (N.O./N.C. selectable)			
Analog output ³	1 to 5 V (Load impedance: 47 kΩ min.)			
Temperature fluctuation for analog output	±2% max. (of F.S.) of detecting pressure at 25°C (0 to 50°C)			
Temperature fluctuation for display	±1% max. (of F.S.) of detecting pressure at 25°C (0 to 50°C)			
Current consumption	50 mA (at 24 V), 90 mA (at 12 V)			
Power supply	12 to 24 VDC±10%, Ripple (p-p): 10% max.			
Ambient temperature	0 to 50°C			
Relative humidity	35 to 85%			
Vibration	10 to 55 Hz, 1.5 mm double amplitude in X, Y, and Z directions, 2 hours respectively			
Material	Front housing: Polyamide, Front panel sheet: PET, Rear housing: Polysulfone, Pressure port: Die-cast zinc, Cable: Oil-proof cabletyre cable			
Weight (including 2 m cable)	Approx. 120 g			

1. The zero-shift type sensor is suffixed with Z after the model name.

2. Z type only. 3. Not provided with Z type

ACCESSORIES

- Instruction manual: 1
- Hexagonal-socket port stopper: 1
- Display unit label sheet: 1
- Quick reference sheet: 1
- Mounting bracket A: 1
- Mounting bracket B: 1

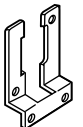
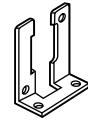

CONNECTIONS AND INPUT/OUTPUT CIRCUIT

Connections

Drive current load

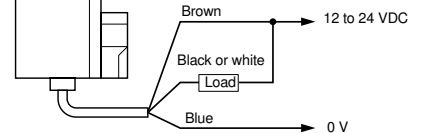

Input to voltage input equipment

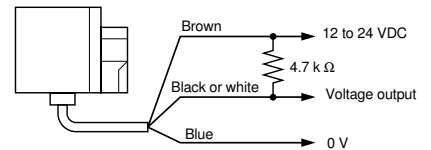

Input/output circuit

Output circuit

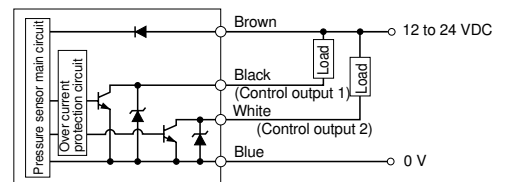

AP-31Z/32Z/33Z/34Z (Z type only)

Input circuit (Zero-shift input)

Zero-shift input resets the display to "0" at the rising edge of the signal.

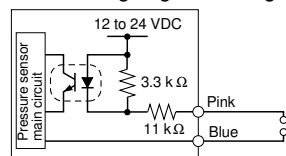

AP-31/32/33/34 (Except for Z type)

Analog output circuit

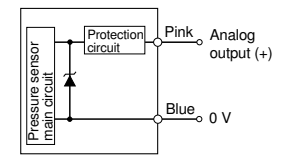

PIPING/MOUNTING

- You can select from three pressure port positions by selecting or replacing the pressure ports. Select the optimal position based on your location.

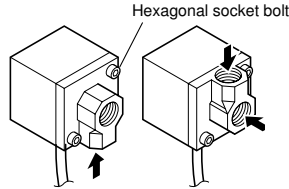

* The arrow shows the pressure port positions that can be selected.

CAUTION

The maximum tightening torque for the hexagonal socket bolt is 0.3 Nm (Approx. 3 kgf-cm). To avoid breakage, do not exceed the specified value.

- An Rc (PT) 1/8 internal thread is provided on the pressure port of the AP-30 series. Commercially available air-pressure pipe joints or nipples can be used.

- When connecting a joint or a plug, use a wrench (14 mm) to hold the metallic part as shown in the figure to avoid a large force being applied to the sensor housing (resin part).

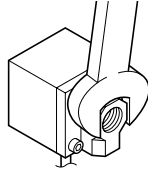

Hold this part with a wrench (14 mm).

- Be sure to block an unused pressure port with the hexagonal-socket port stopper provided.

CAUTION

The maximum tightening torque for the hexagonal-socket port stopper is 10 Nm (Approx. 100 kgf-cm). To avoid breakage, do not exceed the specified value.

- To prevent air leaks, wrap the male screw with sealing tape.
- To mount the AP-30 series to a panel using the panel mounting holder set (OP-31357), use a panel with 1 to 3.5 mm thickness.

- Special mounting brackets are included with the AP-30 series. Use the type of mounting bracket appropriate for the location where the sensor is mounted. To mount the sensor, remove the hexagonal socket bolts and then retighten them through the mounting bracket.

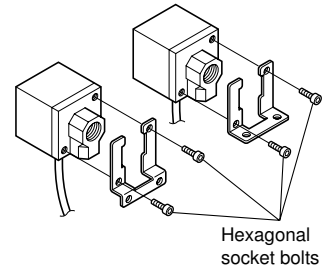

CAUTION

The maximum tightening torque for the hexagonal socket bolt is 0.3 Nm (Approx. 3 kgf-cm). To avoid breakage, do not exceed the specified value.

SAFETY PRECAUTIONS

Be sure to follow the instructions below to avoid malfunctions.

CAUTION

■ Connection

- When using a commercially available switching regulator, be sure to ground the frame ground terminals.
- Isolate the sensor's wiring from power lines or high-voltage lines; otherwise, the sensor may malfunction due to noise interference.

■ Other

- Do not use the AP-30 series for the detection of corrosive gases or liquid.
- Do not insert any objects, such as wires, from the pressure port. The pressure-sensing element may break, resulting in malfunctions.
- Do not press the front panel keys with a pointed object.
- The AP-30 series does not have an explosion-proof structure. Do not use it for the detection of flammable gases.

OPERATION MODE SELECTION

■ Auto-tuning mode (F-1)

Using the AUTO key, detect the upper limit value (A) and the lower limit value (b). The detection level (C) is automatically set at the midpoint between the two values. (You can finely adjust the preset value C within the range between A and b.)

Control output 1: The sensor turns on when the pressure exceeds the preset value C.

Control output 2: The sensor turns on when the pressure goes outside the stability levels.

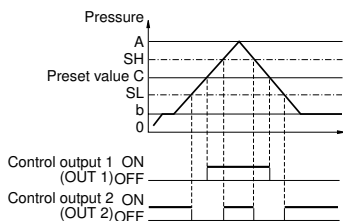

* The stability levels are automatically set as shown in the following calculations.

$$SH = \frac{(A + C)}{2}$$

$$SL = \frac{(C + b)}{2}$$

■ Hysteresis mode (F-2)

Set desired detection level (H) and hysteresis (h) for the detection.

Control output 1: The sensor turns on when the pressure exceeds the preset value H. When the pressure falls by the preset value h, the sensor turns off.

Control output 2: The sensor turns on when the pressure goes outside the hysteresis width (H - h).

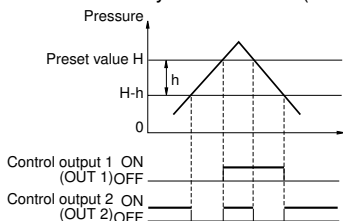

h: Hysteresis width of OUT1

* When h is set to a value close to 0, if pressure fluctuates around the detection point, OUT1 will chatter.

■ 2-independent mode (F-3)

Set two desired detection points (A and B).

Control output 1: The sensor turns on when the pressure exceeds the preset value A.

Control output 2: The sensor turns on when the pressure exceeds the preset value b.

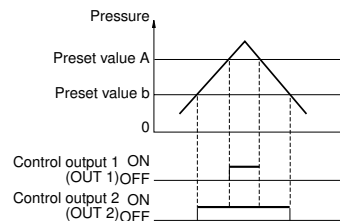

■ Window mode (F-4)

Set desired upper limit value (H) and lower limit value (L).

Control output 1: The sensor turns off when the pressure goes outside of the range between the upper limit value (H) and lower limit value (L).

Control output 2: The sensor turns off when the pressure goes outside of the stability levels.

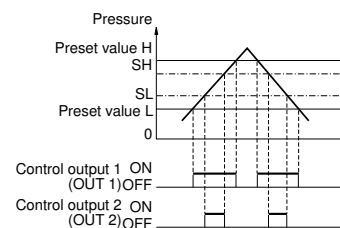

* The stability levels are automatically set as shown in the following calculations.

$$SH = H - \frac{(H - L)}{4}$$

$$SL = L + \frac{(H - L)}{4}$$

Note 1: The above description shows the operation of control outputs 1 and 2 when the output selector switch is set to N.O.

When the output selector switch is set to N.C., the operation of control outputs 1 and 2 is inverted.

Note 2: Except for OUT1 in hysteresis mode, each control output includes an internal hysteresis of 0.5% of F.S.

ADJUSTMENT

Measurement mode

Press the button for 3 seconds or more.

Press the button once.

Unit Setting

Determine the desired units.

In measurement mode, press for at least 3 seconds. “- - -” appears first, and then the current units are displayed. Use or to select the desired units. Pressing completes the unit setting procedure and enters operation mode selection.

Std	AP-31/34: mmHg, AP-32/33: kgf/cm ²	PR	AP-31/32/34: kPa, AP-33: MPa
PS	psi	* When the units are changed, the preset values are automatically converted to appropriate values for the updated units.	

Press the button once.

Operation Mode

Determine the desired operation mode.

(⇒ Refer to “OPERATION MODE SELECTION” on page 2.)

The current operation mode is displayed. Use or to select the operation mode. Pressing completes the operation mode setting procedure and enters N.O./N.C. selection.

F-1	Auto-tuning mode	F-2	Hysteresis mode
F-3	2-independent output mode	F-4	Window mode

Press the button once.

N.O./N.C. Selection

Select N.O. (normally open) or N.C. (normally closed).

The current selection of “no” (normally open) or “nc” (normally closed) is displayed. Use or to select the desired mode. Pressing completes the N.O./N.C. selection procedure and enters the chattering prevention setting.

Press the button once.

Chattering Prevention

Determine the desired response time.

The current response time is displayed. Use or to select the response time. Pressing completes the setting procedure and enters the display color selection.

2.5	2.5 ms
5	5 ms
100	100 ms
500	500 ms

Press the button once.

Display Color Selection

Determine the desired LED color for numerical value display.

The current color is displayed. Use or to select the color. Pressing completes the setting procedure and returns to the measurement mode.

1-L	Red LED only
2-L	Red/green LED

* The setting is saved in the EEPROM.

Zero-point adjustment

At normal atmospheric pressure (1 atm.), press for at least 2 seconds in measurement mode. The display changes to “----”, then to “0”. The zero adjustment function can be used when the pressure is within ±5% of F.S.

Preset Value Input Mode

Determine the preset values.

Auto-tuning mode (F-1)

- In measurement mode with the current measured value displayed, press . The AP-30 enters the preset value input mode.
- “A” and the current preset value flash alternately.
- Position the target at the desired upper (lower) limit.
- Press to register the value. The updated value is displayed for 1 second.
- “b” and the current preset value flash alternately.
- Position the target at the desired lower (upper) limit.
- Press to register the value. The updated value is displayed for 1 second.
- “C” and the calculated preset value C flash alternately. (You can change the C value to any value between A and b using or .)
- Press to register the C value. The setting procedure is completed and the unit returns to measurement mode.

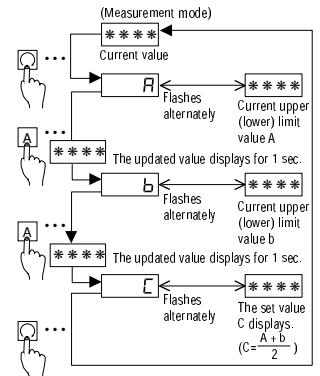

* To confirm the preset value, press repeatedly.

Example of auto-tuning mode setting: Confirmation of work piece pick-up.

Set the upper limit (A) to the position where the work piece is taken. Set the lower limit (b) to the position where the nozzle becomes open after releasing the work piece. Press to register the upper and lower limit values. The C value is automatically set to the midpoint between the upper and lower limit values.

Hysteresis Mode (F-2), 2-independent Output Mode (F-3), Window Mode (F-4)

- In measurement mode with the current measured value displayed, press . The AP-30 enters the preset value input mode.
- “H” 1. and the current preset value flash alternately.
- Use or to change the value to the desired value. Press to register the updated H value.
- “h” 2. and the current preset value flash alternately.
- Use or to change the value to the desired value. Press to register the updated h value.
- “P” 3. and the shift value of the zero-shift adjustment flash alternately.
- Press to complete the setting procedure and return to measurement mode.

[Example: In hysteresis mode]

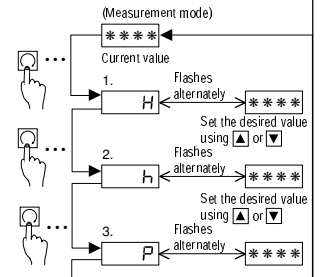

- “A” appears in the 2-independent output mode.
- “b” appears in the 2-independent output mode.
- “L” appears in the window mode. Shown with Z type only.

* To confirm the preset value, press repeatedly.

Note 1: In hysteresis mode, (h - F.S.) cannot be set to a value greater than H.

Note 2: In window mode, (L + 1% of F.S.) cannot be set to a value greater than H.

* The setting is saved in the EEPROM.

Note 1: When the operation mode is changed, check the preset values in the preset value input mode.

Note 2: When units of psi are selected with the AP-34Z, the display range becomes 19.99 to 19.99.

Note 3: Perform the zero-shift adjustment periodically.

Note 4: The initial output voltage may fluctuate by ±1.0% immediately after the power is turned on. To measure minute differences in pressure, let the sensor warm up for approximately 15 to 30 minutes.

OTHER FUNCTIONS AND ERROR INDICATION

■ Zero-shift function (Z type only)

The zero-shift function is used to reset the current pressure value to "0" using an external signal input, in order to prevent measurements from being affected by fluctuations in base pressure.

Example: Leakage test

Input a zero-shift value after air supply is completed so that air leakage after a specified time is displayed as a negative value. The AP-30's detection is unaffected by fluctuations in air supply volume.

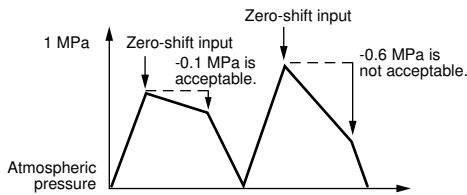

When the power is turned off, the value updated after the zero-shift input (zero-shift value) is lost.

Note 1: The zero-shift function cannot be used in auto-tuning mode.

Note 2: The zero-shift input is effective when the current pressure is between -3% of F.S. and F.S. for a shift of 0 (P = 0).

Note 3: If the applied pressure is outside the range of -15% to 110% of the rated pressure, "-FFF" or "FFF" appears.

■ Key protection function

The key protection function is used to lock the front panel key in order to prevent preset values from being accidentally changed.

To enable the key protection function, hold down [A] and press [▲]. "L_oc" flashes for 2 seconds and the keys are locked.

To disable the key protection function, again hold down [A] and press [▼]. "UnL" flashes for 2 seconds and the keys are unlocked.

Using the EEPROM, the AP-30 series can retain the preset values even if the power is turned off.

■ Display color selection

You can set the color of the LED display either to the two-color mode which displays the numerical value in green or red according to OUT1, or to the single color mode which always shows the value in red. The two-color display allows you to check the output condition at a glance. (Refer to "ADJUSTMENT" on page 3 for the setting procedure.)

In two-color mode (Regardless of N.O./N.C. selection)

- When OUT1 is turned on: Red
- When OUT1 is turned off: Green

■ Peak-hold/bottom-hold display function

The AP-30 series internally updates the peak-hold and bottom-hold values at all times.

● To display hold values

- While [▲] is held down in measurement mode, the peak-hold value is displayed.
- While [▼] is held down in measurement mode, the bottom-hold value is displayed.

● To reset the peak-hold and bottom-hold values

- Hold down [▲] and press [▼] in measurement mode.

● The peak-hold and bottom-hold values are also reset using the following procedure.

- Turn the power off.
- Press [□] for 3 seconds or more and change any settings.

Note: The hold values cannot be displayed when the front panel keys are locked with the key protection function. Disable the function before displaying the hold values.

■ Analog output function (Except for Z type)

The voltage value according to the pressure value is output.

Model	1 V to 5 V
AP-31	0 to -101.3 kPa
AP-32	0 to +100.0 kPa
AP-33	0 to +1.000 MPa
AP-34	+101.3 to -101.3 kPa

■ Error indications and remedies

Error indication	Problem	Remedy
E	Zero-point adjustment was executed at a pressure of ±5% or more of F.S.	Perform zero-point adjustment at normal atmospheric pressure.
E _c	Overcurrent through OUT1 or 2	Turn power off and adjust the load so that the current is within the rated range.
-FFF, FFF	Applied pressure was outside of the display range.	Adjust the pressure to within the rated range.

■ N.O./N.C. selection

The N.O. or N.C. output can be selected according to the device's control method. When the output status is changed, the color of the numerical value display LED is inverted.

■ Chattering prevention function

The chattering prevention function is used to prevent outputs from chattering by changing the response time. The response time can be selected from 4 settings. When the detection (non-detection) state continues for more than a preset response time, the output is produced.

DIMENSIONS

AP-30 (Sensor unit)

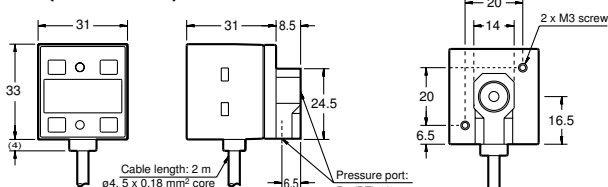

When mounting bracket A is attached

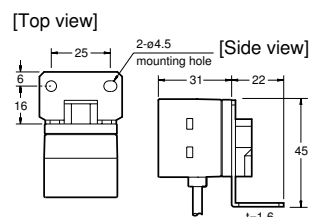

Mounting bracket A (Accessory)

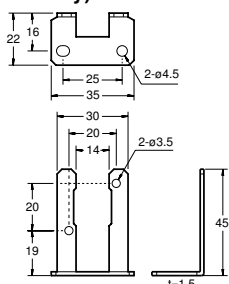

Mounting bracket B (Accessory)

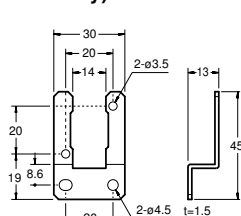

When mounting bracket B is attached

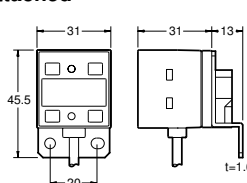

KEYENCE

Worldwide Headquarters
KEYENCE CORPORATION
 1-3-14, Higashi-Nakajima, Higashi-Yodogawa-ku,
 Osaka, 533-8555, Japan
 PHONE: 81-6-379-2211 FAX: 81-6-379-2131

KEYENCE CORPORATION OF AMERICA
 PHONE: 201-930-0100 FAX: 201-930-0099

KEYENCE (UK) LIMITED
 PHONE: 01908-696900 FAX: 01908-696777

KEYENCE DEUTSCHLAND GmbH
 PHONE: 0711-7973710 FAX: 0711-797799

KEYENCE FRANCE S.A.
 PHONE: 01 47 92 76 76 FAX: 01 47 92 76 77

KEYENCE SINGAPORE PTE LTD
 PHONE: 392-1011 FAX: 392-5055

KEYENCE SENSORS & MEASURING SDN BHD
 PHONE: 03-252-2211 FAX: 03-252-2131

KEYENCE (THAILAND) CO., LTD
 PHONE: 02-934-6772~4 FAX: 02-934-6775

KEYENCE KOREA CORPORATION
 PHONE: 02-563-1270 FAX: 02-563-1271

© KEYENCE CORPORATION, 1998
 AP3-IM-1-0398 Printed in Japan

Specifications are subject to change without notice.